

# Nasal Septal Perforation Prosthesis

**Blom-Singer®**

The voice of experience since 1978

## Two-piece magnetically coupled prosthesis

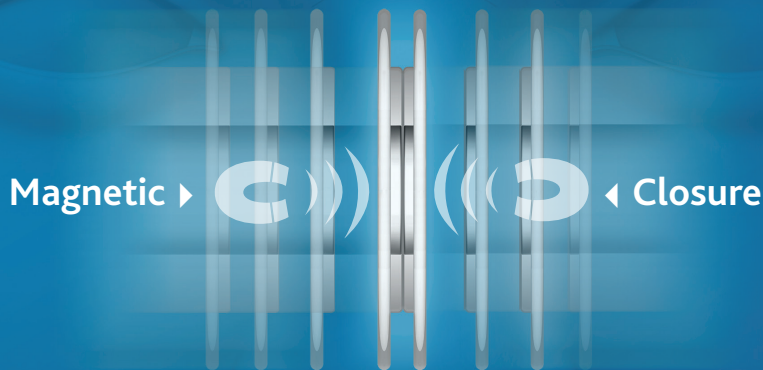

A study of patients using a two-piece magnetically coupled prosthesis showed:

- No particular discomfort on insertion, removal, or replacement<sup>1</sup>
- Easier debris removal for ENTs<sup>1</sup>

## Choice of shape, size and thickness for a comfortable fit

Two medical-grade, silicone-covered neodymium magnets couple securely.

Multiple options – round or oval, 6 sizes each – help ensure an accurate fit:

- Less pistoning
- Less side-to-side movement

## Reduce or eliminate symptoms:

- Bleeding, crusting, whistling, epistaxis, infection<sup>2</sup>

Oval

Round

**INHEALTH®**  
TECHNOLOGIES

*We speak ENT*

# Nasal Septal Perforation Prosthesis

**Blom-Singer®**

The voice of experience since 1978

## OVAL

### 11 x 13 mm

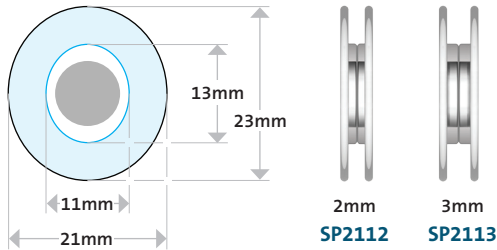

### 13 x 17 mm

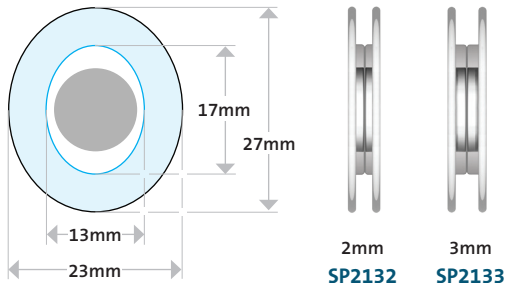

### 15 x 21 mm

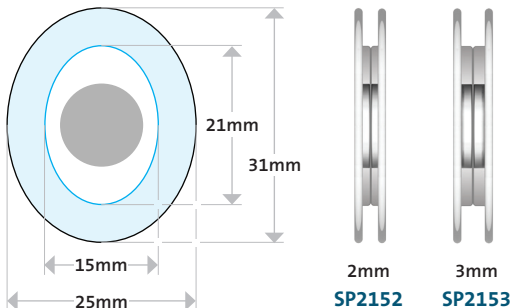

## ROUND

### 5 mm

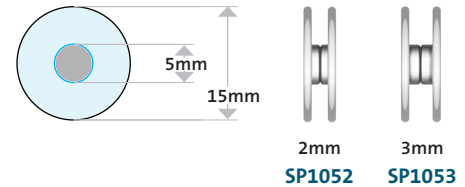

### 7 mm

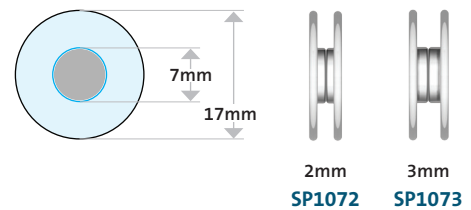

### 10 mm

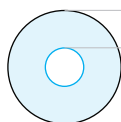
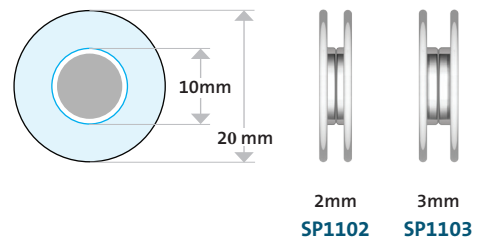

Flange width is 5mm for all prostheses.

**Diagrams actual size**

1. Teschner M, et al. *Eur Arch Otorhinolaryngol.* 2012; 269:861-865  
 2. Mullace, M, et al. *Acta Otorhinolaryngol Ital* 26. 2006; 216-218

The Blom-Singer Nasal Septal Perforation Prosthesis was designed by Eric D. Blom, Ph.D., co-inventor of the breakthrough in voice restoration: the Blom-Singer Voice Prosthesis.

© 2017 InHealth Technologies — Manufactured by Freudenberg Medical, LLC (LT SEPTAL-C)

**INHEALTH®**  
 TECHNOLOGIES

*We speak ENT*

UNITED STATES  
 1110 Mark Avenue  
 Carpinteria, CA 93013-2918 USA  
 Toll Free: 800.477.5969  
 Toll Free Fax: 888.371.1530

ORDER ONLINE  
[www.inhealth.com](http://www.inhealth.com)